

29" Soundbar with Bluetooth Wireless

User's Guide for Model ITB037 v1946-01



FCC WARNINGS

Warning: Changes or modifications to this unit not expressly approved by the party responsible for compliance could void the user's authority to operate the equipment.
NOTE: This equipment has been tested and found to comply with the limits for a Class B digital device, pursuant to Part 15 of the FCC Rules. These limits are designed to provide reasonable protection against harmful interference in a residential installation. This equipment generates, uses, and can radiate radio frequency energy and, if not installed and used in accordance with the instructions, may cause harmful interference to radio communications. However, there is no guarantee that interference will not occur in a particular installation. If this equipment does cause harmful interference to radio or television reception, which can be determined by turning the equipment off and on, the user is encouraged to try to correct the interference by one or more of the following measures:

- Reorient or relocate the receiving antenna.
- Increase the separation between the equipment and receiver.
- Connect the equipment into an outlet on a circuit different from that to which the receiver is connected.
- Consult the dealer or an experienced radio/TV technician for help.

ADDITIONAL WARNINGS

- **WARNING:** Shock hazard - Do Not Open.
- Caution and marking information is located at the rear or bottom of the apparatus.
- Mains plug is used as disconnect device and it should remain readily operable during intended use. In order to disconnect the apparatus from the mains completely, the mains plug should be disconnected from the mains socket outlet completely.
- **CAUTION: TO PREVENT ELECTRIC SHOCK, MATCH WIDE BLADE OF PLUG TO WIDE SLOT, FULLY INSERT.**
- Objects filled with liquids, such as vases, shall not be placed on the apparatus
- **WARNING:** Do not place this unit directly onto furniture surfaces with any type of soft, porous, or sensitive finish. As with any rubber compound made with oils, the feet could cause marks or staining where the feet reside. We recommend using a protective barrier such as a cloth or a piece of glass between the unit and the surface to reduce the risk of damage and/or staining.
- **WARNING:** This product may contain chemicals known to the State of California to cause birth defects, or other reproductive harm (California Prop 65). Wash hands after handling.
- This product meets and complies with all Federal regulations.

Overview

Side Controls & Input

- Power/Source**
Press to power ON.
Press and hold to power OFF.
Press to change audio source.
- Volume +/-**
Press to adjust the volume up or down.
- Pair**
Press to begin pairing to a Bluetooth device.

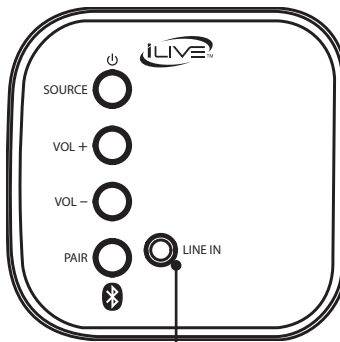

Line In
Requires 3.5mm audio cable (not included).

Rear Inputs

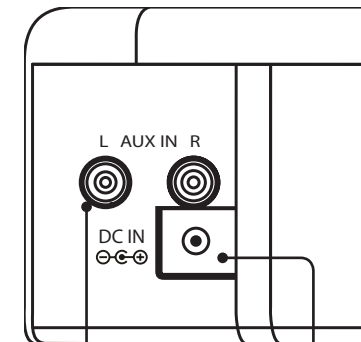

Aux In
Requires RCA stereo audio cable (included).

DC Power Port

- Power**
Press to power ON/OFF.
- Mute**
Press to mute audio.
- Aux/Line In**
Press to switch to Aux or Line In mode.
- Volume -/+**
Volume -/+
- Bluetooth**
Press to switch to Bluetooth mode.
Remote does not initiate pairing, use Pair button on speaker.
- Skip Back/Fwd**
In Bluetooth mode, press to skip the selected track.
- Play/Pause**
In Bluetooth mode, press to play or pause the selected track.

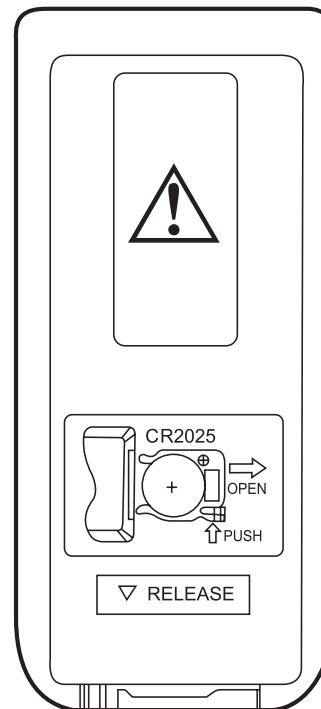
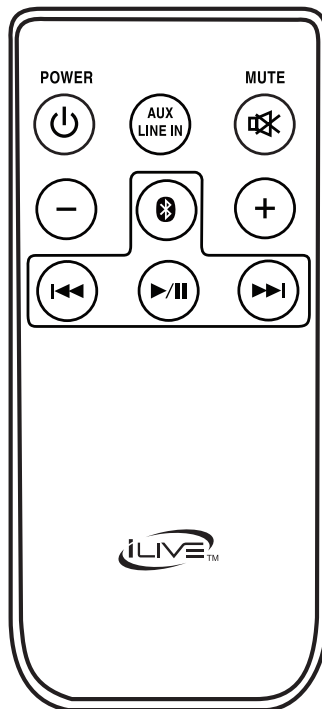

Remote requires 1 CR2025 button cell battery (included).

Power

Plug the power cord (included) into the DC Input on the back of the unit and a standard wall outlet.

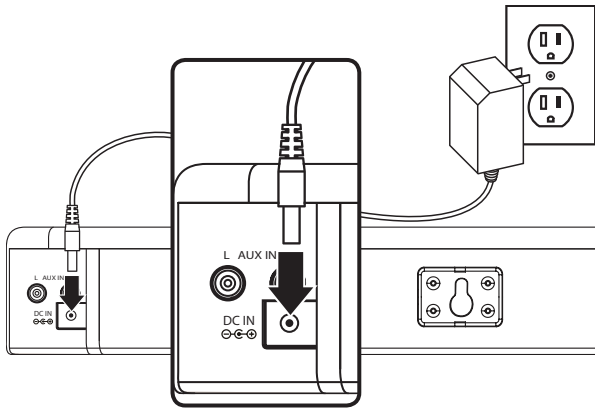

Bluetooth Wireless Audio

Pairing to a Device & Playing Audio

After initial pairing, the unit will stay paired unless unpaired manually by the user or erased due to a reset of the device. If your device should become unpaired or you find it is unable to connect, repeat the steps listed here.

1. Power ON the unit and press **Source** to select **Bluetooth Mode**. Press & Hold the **Pair** button to begin pairing. The **Pairing indicator** will begin flashing quickly. *When pairing, remain within 3 feet of the unit.*
2. Using the controls on your Bluetooth device, search for and select **ITB037** in your Bluetooth settings to pair. If your device requests a password, enter the default password **0000**. *If need be, refer to the user's manual for your specific device for instructions on connecting Bluetooth devices.*
3. When successfully paired, the **Pairing indicator** will turn solid and an audible chime will sound. Use the controls on the connected device to select and begin playing audio.

Aux In (Stereo RCA Inputs)

Requires RCA stereo audio cable (included). When connecting an RCA stereo audio cable (Red/White), match the colored ports to their corresponding plugs.

1. Connect the RCA stereo audio cable to the Aux Inputs on the soundbar and the audio outputs on a television or other audio source.
2. Power ON the soundbar and press **Source** or **Aux/Line In** to select **Aux In Mode**.
3. Audio played through the television or other source should now be heard through the speakers.

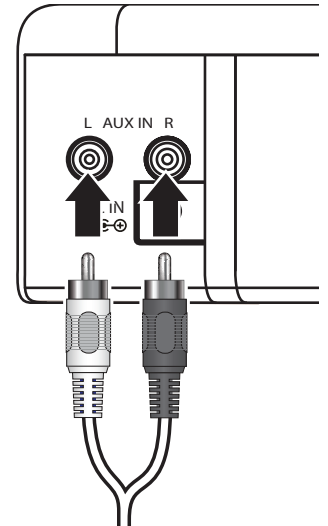

Line In

Requires a 3.5 mm audio cable (not included).

1. Using a 3.5 mm audio cable, plug into the **Line In** on the soundbar and the audio output/headphone jack on an MP3 Player or other audio source.
2. Power ON the soundbar and press **Source** or **Aux/Line In** to select **Aux In Mode**. *The indicator light will display green. Connecting via Line In overrides the Aux In source. Remove the 3.5mm audio cable to hear Aux In again.*
3. Audio played through the connected device should now be heard through the speakers. Use the controls on the connected device to play, pause, or skip selected tracks.

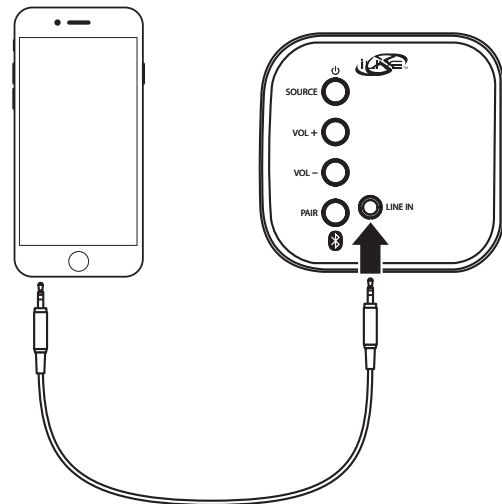

International Support

To download this User's Guide in English, Spanish, or French, or to get answers to frequently asked questions, visit the support section at: www.iLiveElectronics.com

Para descargar este Manual del Usuario en inglés, español y francés, o para obtener respuestas a preguntas frecuentes, visite la sección de apoyo en: www.iLiveElectronics.com

Pour télécharger ce guide de l'utilisateur en anglais, espagnol ou français, ou pour obtenir des réponses à des questions fréquemment posées, consultez la rubrique d'assistance sur: www.iLiveElectronics.com

For Warranty Information and the most up-to-date version of this User's Guide, go to www.iLiveElectronics.com

Customer Service: 1-888-999-4215 | **Email Support:** prodinfo@dpiinc.com | **Email Parts:** partsinfo@dpiinc.com

Copyright © 2017 Digital Products International (DPI, Inc.) All other trademarks appearing herein are the property of their respective owners. Specifications are subject to change without notice.



**Protect for Today
Sustain for Tomorrow**