

IMPORTANT SAFETY INSTRUCTIONS

1. Read these Instructions.
2. Keep these Instructions.
3. Heed all Warnings.
4. Follow all instructions.
5. Do not use this apparatus near water.
6. Clean only with a dry cloth.
7. Do not block any ventilation openings. Install in accordance with the manufacturer's instructions.
8. Do not install near any heat sources such as radiators, heat registers, stoves, or other apparatus (including amplifiers) that produce heat.
9. Do not defeat the safety purpose of the polarized or grounding-type plug. A polarized plug has two blades with one wider than the other. A grounding type plug has two blades and a third grounding prong. The wide blade or the third prong are provided for your safety. When the provided plug does not fit into your outlet, consult an electrician for replacement of the obsolete outlet.
10. Protect the power cord from being walked on or pinched particularly at plugs, convenience receptacles, and the point where they exit from the apparatus.
11. Only use attachments/accessories specified by the manufacturer.
12. Use only with a cart, stand, tripod, bracket, or table specified by the manufacturer, or sold with the apparatus. When a cart is used, use caution when moving the cart/apparatus combination to avoid injury from tip-over. Unplug this apparatus during lightning storms or when unused for long periods of time.
13. Refer all servicing to qualified service personnel. Servicing is required when the apparatus has been damaged in any way, such as power-supply cord or plug is damaged, liquid has been spilled or objects have fallen into the apparatus, the apparatus has been exposed to rain or moisture, does not operate normally, or has been dropped.



FCC Warnings

Warning: Changes or modifications to this unit not expressly approved by the party responsible for compliance could void the user's authority to operate the equipment.

NOTE: This equipment has been tested and found to comply with the limits for a Class B digital device, pursuant to Part 15 of the FCC Rules. These limits are designed to provide reasonable protection against harmful interference in a residential installation. This equipment generates, uses, and can radiate radio frequency energy and, if not installed and used in accordance with the instructions, may cause harmful interference to radio communications. However, there is no guarantee that interference will not occur in a particular installation. If this equipment does cause harmful interference to radio or television reception, which can be determined by turning the equipment off and on, the user is encouraged to try to correct the interference by one or more of the following measures:

- Reorient or relocate the receiving antenna.
- Increase the separation between the equipment and receiver.
- Connect the equipment into an outlet on a circuit different from that to which the receiver is connected.
- Consult the dealer or an experienced radio/TV technician for help.

Additional Warnings

- The apparatus shall not be exposed to dripping or splashing and that no objects filled with liquids, such as vases, shall be placed on apparatus.
L'appareil ne doit pas être exposé aux écoulements ou aux éclaboussures et aucun objet ne contenant de liquide, tel qu'un vase, ne doit être placé sur l'objet.
- Main plug is used as disconnect device and it should remain readily operable during intended use. In order to disconnect the apparatus from the mains completely, the mains plug should be disconnected from the mains socket outlet completely.
La prise du secteur ne doit pas être obstruée ou doit être facilement accessible pendant son utilisation. Pour être complètement déconnecté de l'alimentation d'entrée, la prise doit être débranchée du secteur.
- Battery shall not be exposed to excessive heat such as sunshine, fire or the like.
Les piles ne doivent pas être exposées à de forte chaleur, tel qu'à la lumière du soleil, au feu ou autres choses de semblable.
- Caution marking is located at the rear or bottom of the apparatus.
Attention marquage est situé sur le panneau arrière ou inférieur de l'unité.
- The marking information is located at the rear or bottom of apparatus.
Le marquage est situé sur le panneau arrière ou inférieur de l'unité.

WARNINGS AND PRECAUTIONS

- **CAUTION: TO PREVENT ELECTRIC SHOCK, MATCH WIDE BLADE OF PLUG TO WIDE SLOT, FULLY INSERT.**
- **WARNING:** To reduce the risk of fire or electric shock, do not expose this apparatus to rain or moisture.
- **AVERTISSEMENT:** Pour réduire le risque d'incendie ou de choc électrique, ne pas exposer cet appareil sous la pluie et l'humidité.
- **CAUTION:** Use of controls or adjustments or performance of procedures other than those specified may result in hazardous radiation exposure.
- **WARNING:** Changes or modifications to this unit not expressly approved by the party responsible for compliance could void the user's authority to operate the equipment.
- **WARNING:** Do not place the unit on top of any soft, porous, or sensitive surfaces to avoid damaging the surface. Use a protective barrier between the unit and surface to protect the surface.
- **WARNING:** Use of this unit near fluorescent lighting may cause interference regarding use of the remote. If the unit is displaying erratic behavior move away from any fluorescent lighting, as it may be the cause.
- **CAUTION:** Danger of explosion if battery is incorrectly replaced. Replace only with the same or equivalent type.
- **WARNING:** Shock hazard - Do Not Open.
- **AVIS: RISQUE DE CHOC ÉLECTRIQUE - NE PAS OUVRI**



WARNING: TO REDUCE THE RISK OF ELECTRIC SHOCK, DO NOT REMOVE COVER (OR BACK). NO USER-SERVICEABLE PARTS INSIDE. REFER SERVICING TO QUALIFIED SERVICE PERSONNEL.



The lightning flash with arrowhead symbol, within an equilateral triangle, is intended to alert the user to the presence of "uninsulated dangerous voltage" within the product's enclosure that may be of sufficient magnitude to constitute a risk of electric shock to persons.



The exclamation point within an equilateral triangle is intended to alert the user to the presence of important operating and maintenance (servicing) instructions in the literature accompanying the appliance.



This symbol indicates that this product incorporates double insulation between hazardous mains voltage and user accessible parts.

Introduction and Setup

Power

Plug the attached AC cord into a standard AC power outlet to power the DVD player.

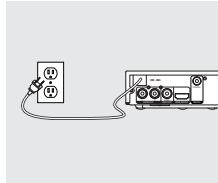

Remote

Requires 2 AAA batteries (not included).

Do not mix old and new batteries. Do not mix alkaline, standard (carbon-zinc), or rechargeable (ni-cad, ni-mh, etc) batteries

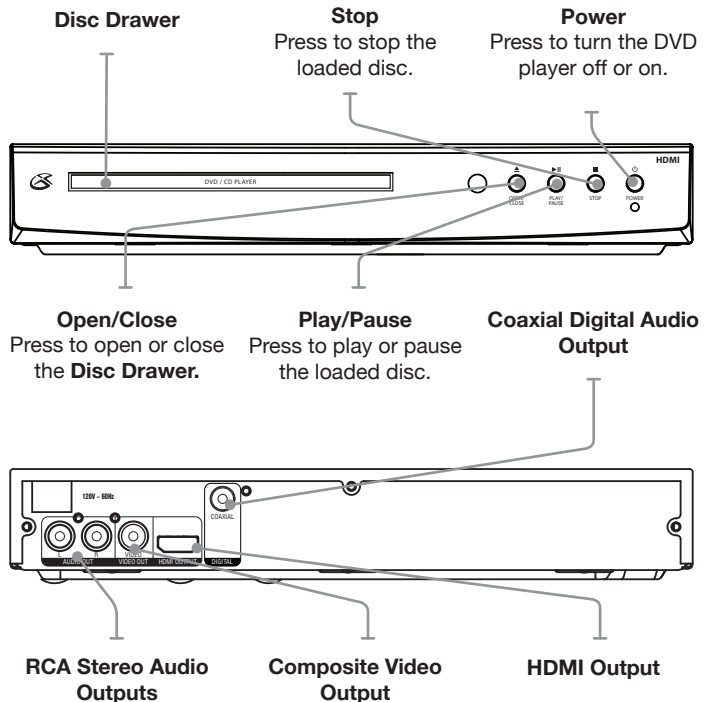
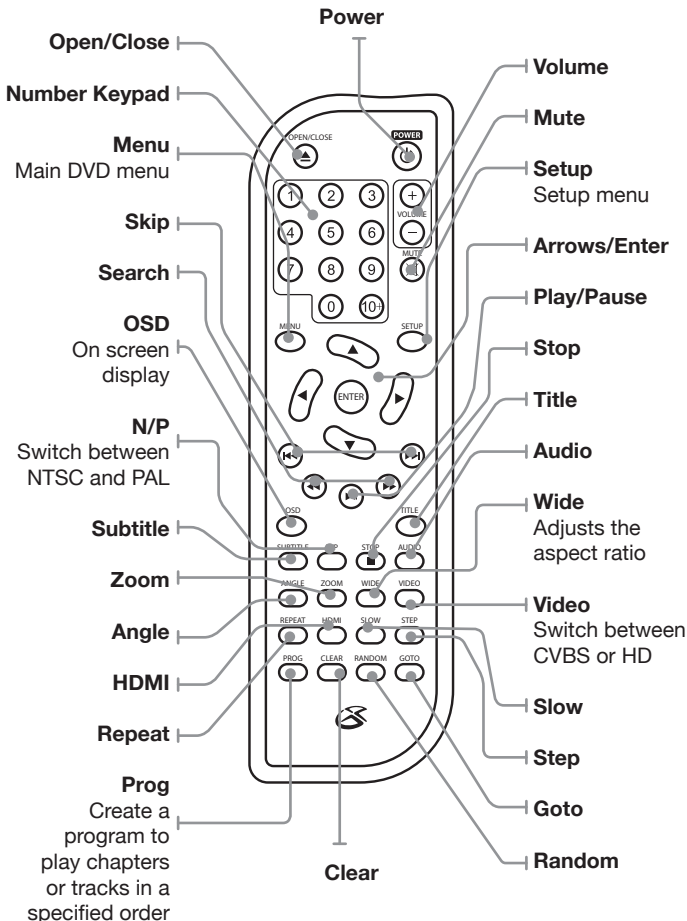
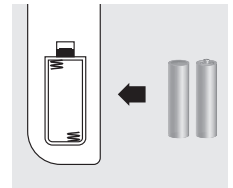

DVD and CD

Loading a Disc

1. Press the **Open/Close** button to open the **Disc Drawer**.
2. Load a disc into the DVD player, label side facing up.
3. Press the **Open/Close** button to close the **Disc Drawer**.
4. After a disc is loaded, it will begin playing automatically.

Playing a Loaded Disc

1. Follow the instructions for Loading a Disc.
2. If the disc does not begin playing automatically, press the **Play/Pause** button.

Programming a Loaded Disc

1. Follow the instructions for Loading a Disc and Playing a Loaded Disc.
2. While the loaded disc is playing, press the PROG button on the remote.
3. Use the **Arrows/Enter/Number Keypad** buttons to highlight and select a DVD title and chapter, or CD track.
4. Highlight the PLAY button to play.
5. DVD Titles and chapters or CD tracks will play in the order they are programmed.
6. Repeat step 3 until the desired DVD titles and chapters or CD tracks are programmed.

Playing a JPEG CD

1. Load a JPEG photo disc into the player by following the instructions for Loading a Disc.
2. A slide show of JPEG photos from the CD will begin playing automatically.
3. Press the **Stop** button to access a file view of the loaded JPEG disc.
4. Use the **Arrows/Enter** buttons on the remote to select and view photos.

Access the DVD Setup Menu

Press the **Stop** button on the remote twice. In order to access all of the features of the DVD setup menu, the DVD player needs to be fully stopped.

Press the **Setup** button on the remote.

Digital Output Settings

Press the **Setup** button on the remote to access the Audio menu.

- OFF: There will be no digital audio signal output. (Coaxial off)
- RAW: The digital audio signal output will be in its raw format. This mode is usually used for DTS & Dolby Digital 5.1 signals.
- PCM: The digital audio signal output will be in PCM format. This mode is usually used for audio CD signals.

International Support

To download this User's Guide in English, Spanish, or French, or to get answers to frequently asked questions, visit the support section at:

www.gpx.com

Connecting Video and Audio

Note: Before making or changing any connections, make sure that all the devices are disconnected from the power outlet.

Note: Both video and audio connections must be made from the DVD player to your television.

Composite Video Output (Good)

1. Use the **Composite Video Output** to send video from the DVD player to a television.
2. Requires an RCA video cable (included).
3. Use the RCA video cable to connect the **Composite Video Output** to a composite video input on a television.
4. Adjust the connected television's input setting to match the input used in the previous step.

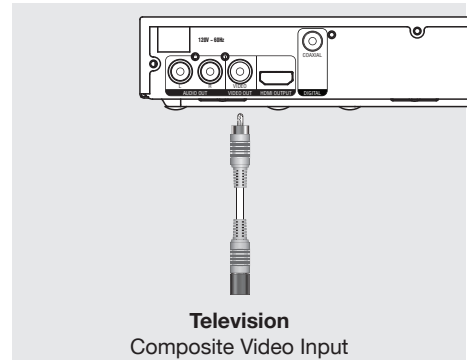

HDMI Output (Better)

1. Use the **HDMI Output** to send high quality video from the DVD player to a television.
2. Requires a HDMI cable (not included).
3. Use a HDMI cable to connect the **HDMI Output** to a HDMI input on a television.
4. Adjust the connected television's input setting to match the input used in the previous step.
5. Press the **HDMI** button on the remote to adjust the display resolution between 480p, 720p, 1080i, and 1080p.

*Note: If the screen remains blank, press the **Video** button repeatedly to enter HDMI Mode.*

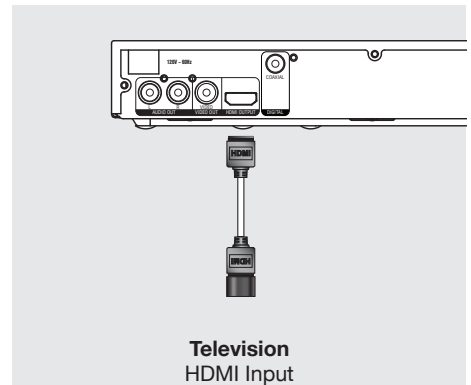

RCA Stereo Audio Output (Good)

1. Use the **RCA Stereo Audio Output** to send audio from the DVD player to a television.
2. Requires an RCA audio cable (included).
3. Use the RCA audio cable to connect the **RCA Stereo Audio Output** to an RCA stereo audio input on a television.
4. Adjust the connected television's input setting to match the input used in the previous step.

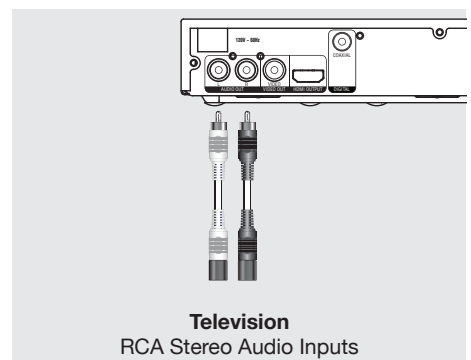

Coaxial Digital Audio Output

1. Use the **Coaxial Digital Audio Output** to send high quality audio from the DVD player to an audio system.
2. Requires an RCA audio cable (included).
3. Use the RCA audio cable to connect the **Coaxial Digital Audio Output** to an coaxial digital audio input on an audio system.
4. Adjust the connected audio system's input setting to match the input used in the previous step.
5. In the **Digital Out** portion of the setup menu, adjust to PCM, RAW or OFF.

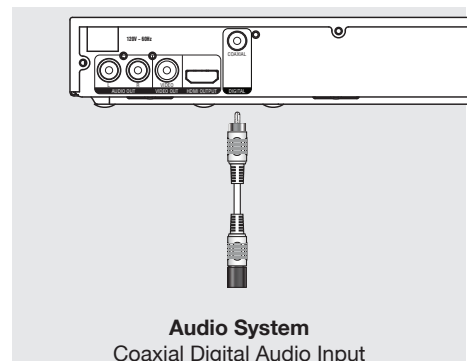

Pour télécharger ce guide de l'utilisateur en anglais, espagnol ou français, ou pour obtenir des réponses à des questions fréquemment posées, consultez la rubrique d'assistance sur

www.gpx.com

Para descargar este Manual del Usuario en inglés, español y francés, o para obtener respuestas a preguntas frecuentes, visite la sección de apoyo en

www.gpx.com