



# IHB23B Cineblue - Wireless Bluetooth 2.1 Speaker System with Subwoofer

## IMPORTANT SAFETY INSTRUCTIONS

1. Read these Instructions.
2. Keep these Instructions.
3. Heed all Warnings.
4. Follow all instructions.
5. Do not use this apparatus near water.
6. Clean only with a dry cloth.
7. Do not block any ventilation openings. Install in accordance with the manufacturer's instructions.
8. Do not install near any heat sources such as radiators, heat registers, stoves, or other apparatus (including amplifiers) that produce heat.
9. Do not defeat the safety purpose of the polarized or grounding-type plug. A polarized plug has two blades with one wider than the other. A grounding type plug has two blades and a third grounding prong. The wide blade or the third prong are provided for your safety. When the provided plug does not fit into your outlet, consult an electrician for replacement of the obsolete outlet.
10. Protect the power cord from being walked on or pinched particularly at plugs, convenience receptacles, and the point where they exit from the apparatus.
11. Only use attachments/accessories specified by the manufacturer.
12. Use only with a cart, stand, tripod, bracket, or table specified by the manufacturer, or sold with the apparatus. When a cart is used, use caution when moving the cart/apparatus combination to avoid injury from tip-over. Unplug this apparatus during lightning storms or when unused for long periods of time.
13. Refer all servicing to qualified service personnel. Servicing is required when the apparatus has been damaged in any way, such as power-supply cord or plug is damaged, liquid has been spilled or objects have fallen into the apparatus, the apparatus has been exposed to rain or moisture, does not operate normally, or has been dropped.



### FCC Warnings

Warning: Changes or modifications to this unit not expressly approved by the party responsible for compliance could void the user's authority to operate the equipment.

NOTE: This equipment has been tested and found to comply with the limits for a Class B digital device, pursuant to Part 15 of the FCC Rules. These limits are designed to provide reasonable protection against harmful interference in a residential installation. This equipment generates, uses, and can radiate radio frequency energy and, if not installed and used in accordance with the instructions, may cause harmful interference to radio communications. However, there is no guarantee that interference will not occur in a particular installation. If this equipment does cause harmful interference to radio or television reception, which can be determined by turning the equipment off and on, the user is encouraged to try to correct the interference by one or more of the following measures:

- Reorient or relocate the receiving antenna.
- Increase the separation between the equipment and receiver.
- Connect the equipment into an outlet on a circuit different from that to which the receiver is connected.
- Consult the dealer or an experienced radio/TV technician for help.

### Additional Warnings

- The apparatus shall not be exposed to dripping or splashing and that no objects filled with liquids, such as vases, shall be placed on apparatus.  
*L'appareil ne doit pas être exposé aux écoulements ou aux éclaboussures et aucun objet ne contenant de liquide, tel qu'un vase, ne doit être placé sur l'objet.*
- Main plug is used as disconnect device and it should remain readily operable during intended use. In order to disconnect the apparatus from the mains completely, the mains plug should be disconnected from the mains socket outlet completely.  
*La prise du secteur ne doit pas être obstruée ou doit être facilement accessible pendant son utilisation. Pour être complètement déconnecté de l'alimentation d'entrée, la prise doit être débranchée du secteur.*
- Battery shall not be exposed to excessive heat such as sunshine, fire or the like.  
*Les piles ne doivent pas être exposées à de forte chaleur, tel qu'à la lumière du soleil, au feu ou autres choses de semblable.*
- Caution marking is located at the rear or bottom of the apparatus.  
*Attention marquage est situé sur le panneau arrière ou inférieur de l'unité.*
- The marking information is located at the rear or bottom of apparatus.  
*Le marquage est situé sur le panneau arrière ou inférieur de l'unité.*

## WARNINGS AND PRECAUTIONS

- **CAUTION:** TO PREVENT ELECTRIC SHOCK, MATCH WIDE BLADE OF PLUG TO WIDE SLOT, FULLY INSERT.
  - **WARNING:** To reduce the risk of fire or electric shock, do not expose this apparatus to rain or moisture.
  - **AVERTISSEMENT:** Pour réduire le risque d'incendie ou de choc électrique, ne pas exposer cet appareil sous la pluie et l'humidité.
  - **CAUTION:** Use of controls or adjustments or performance of procedures other than those specified may result in hazardous radiation exposure.
  - **WARNING:** Changes or modifications to this unit not expressly approved by the party responsible for compliance could void the user's authority to operate the equipment.
  - **WARNING:** Do not place this unit directly onto furniture surfaces with any type of soft, porous, or sensitive finish. As with any rubber compound made with oils, the feet could cause marks or staining where the feet reside. We recommend using a protective barrier such as a cloth or a piece of glass between the unit and the surface to reduce the risk of damage and/or staining.
  - **WARNING:** Use of this unit near fluorescent lighting may cause interference regarding use of the remote. If the unit is displaying erratic behavior move away from any fluorescent lighting, as it may be the cause.
  - **CAUTION:** Danger of explosion if battery is incorrectly replaced. Replace only with the same or equivalent type.
  - **PRÉCAUTION:** Danger d'explosion si les piles sont remplacées de façon incorrect. Remplacer les piles seulement par le même type de pile ou l'équivalent.
  - **WARNING:** There is a danger of explosion if you attempt to charge standard Alkaline batteries in the unit. Only use rechargeable NiMH batteries.
  - **WARNING:** The remote control's button cell battery contains mercury. Do not put in the trash, instead recycle or dispose of as hazardous waste.
  - **WARNING:** Lithium batteries, like all rechargeable batteries are recyclable and should be recycled or disposed of in normal household waste. Contact your local government for disposal or recycling practices in your area. They should never be incinerated since they might explode.
  - **WARNING:** Shock hazard - Do Not Open.
  - **AVIS: RISQUE DE CHOC ÉLECTRIQUE - NE PAS OUVRIR**  
Mains plug is used as disconnect device and it should remain readily operable during intended use. In order to disconnect the apparatus from the mains completely, the mains plug should be disconnected from the mains socket outlet completely.  
*La prise du secteur est utilisé pour déconnecter le système. La prise du secteur ne doit pas être obstruée ou doit être facilement accessible pendant son utilisation. Pour être complètement déconnecté de l'alimentation d'entrée, la prise doit être débranchée du secteur.*
- Do not mix old and new batteries.  
Do not mix alkaline, standard (carbon-zinc), or rechargeable (ni-cad, ni-mh, etc) batteries.  
*No mezcle baterias viejas y nuevas.*  
*No mezcle baterias alcalinas, estándar (carbono-zinc) o recargables (ni-cad, ni-mh, etc).*



**WARNING:** TO REDUCE THE RISK OF ELECTRIC SHOCK, DO NOT REMOVE COVER (OR BACK). NO USER-SERVICEABLE PARTS INSIDE. REFER SERVICING TO QUALIFIED SERVICE PERSONNEL.



The lightning flash with arrowhead symbol, within an equilateral triangle, is intended to alert the user to the presence of "uninsulated" "dangerous voltage" within the product's enclosure that may be of sufficient magnitude to constitute a risk of electric shock to persons.



The exclamation point within an equilateral triangle is intended to alert the user to the presence of important operating and maintenance (servicing) instructions in the literature accompanying the appliance.



This symbol indicates that this product incorporates double insulation between hazardous mains voltage and user accessible parts.

## Setup

### Power

AC power: built-in AC power cable

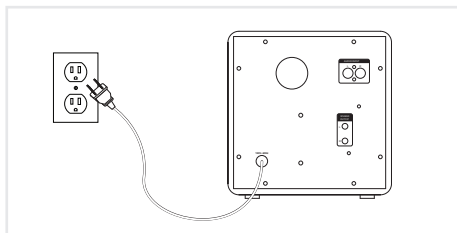

## Introduction

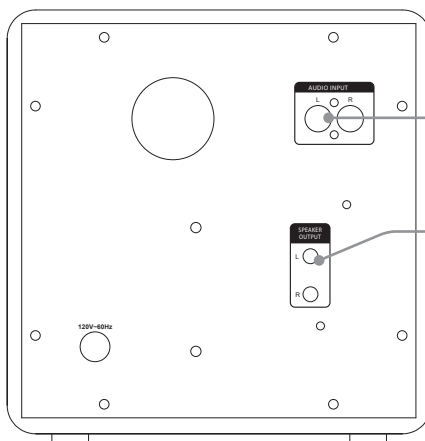

Speaker Connections

RCA Audio Inputs

**Treble**  
Turn to adjust the treble.

**Volume**  
Turn to adjust the volume.

**Bass**  
Turn to adjust the bass.

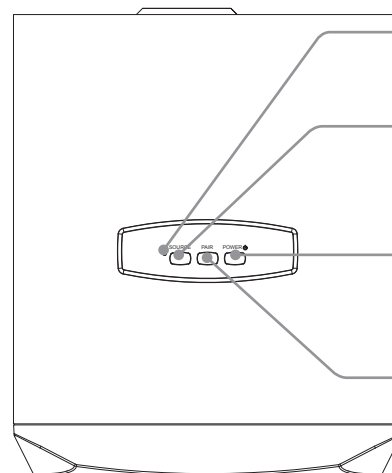
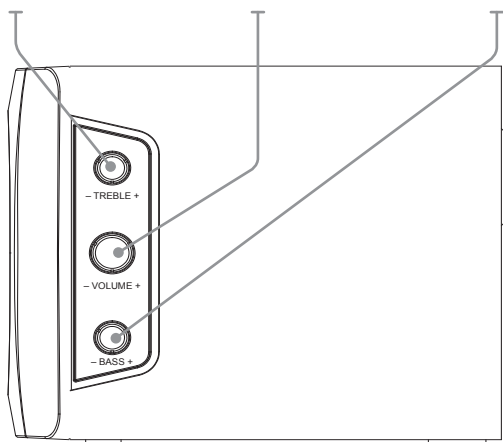

Pairing Indicator

**Source**  
Press to switch between Bluetooth and line in mode.

**Power**  
Press to turn the system on or off.

**Pair**  
Press to begin pairing.

# Setup

## Bluetooth Setup

### Pairing a Bluetooth Device for the First Time

1. Power on the unit by pressing the **Power** button.

*The **Pairing Indicator** will flash blue quickly.*

*When pairing, remain within 3 feet of the unit.*

2. Using the native controls on your Bluetooth device, select the "ISB563" in your Bluetooth settings to pair.

*If your device requests a password, enter the default password "0000".*

*Refer to the user's manual for your specific device for instructions on pairing and connecting Bluetooth devices.*

3. When successfully paired and connected, the **Pairing Indicator** will display a solid blue light.

*After initial pairing, the unit will stay paired unless unpaired manually by the user or erased due to a reset of the device.*

*If your device should become unpaired or you find it is unable to connect, repeat the above steps or press the Pair button to start the pairing process pairing again.*

## Using Bluetooth

### Playing Audio Wirelessly

1. Follow the instructions for [Pairing a Bluetooth Device](#).
2. Use the native controls on the connected Bluetooth Device to select a track.
3. To play or pause the selected track, use the native controls on the connected Bluetooth Device.
4. Audio played through the connected Bluetooth device will now be heard through the speakers.

### Connecting the Speakers

Connect the included speakers to the corresponding speaker connections on the back of the speaker system.

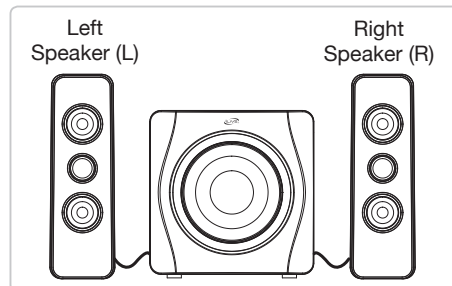
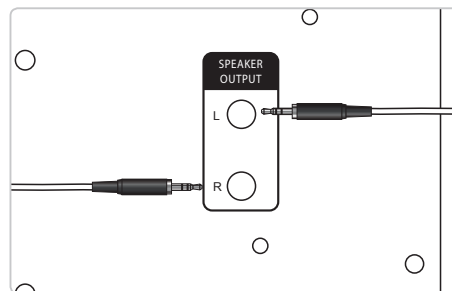

### Using the RCA Audio Inputs

*Requires a 3.5mm to RCA audio cable (included).*

1. Plug the RCA audio cable into the RCA audio inputs on the speaker system and into a 3.5mm audio output on an audio source.
2. Use the native controls on the connected audio source to play, pause, and control audio.

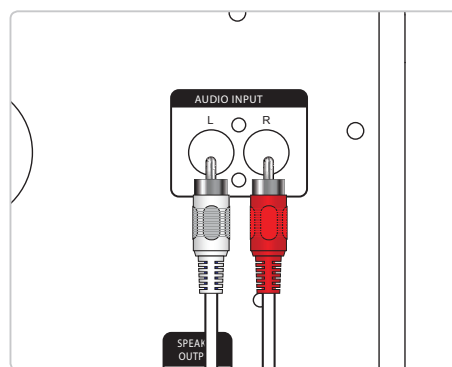

### International Support

To download this User's Guide in English, Spanish, or French, or to get answers to frequently asked questions, visit the support section at: [www.iLiveElectronics.com](http://www.iLiveElectronics.com)

Para descargar este Manual del Usuario en inglés, español y francés, o para obtener respuestas a preguntas frecuentes, visite la sección de apoyo en [www.iLiveElectronics.com](http://www.iLiveElectronics.com)

Pour télécharger ce guide de l'utilisateur en anglais, espagnol ou français, ou pour obtenir des réponses à des questions fréquemment posées, consultez la rubrique d'assistance sur [www.iLiveElectronics.com](http://www.iLiveElectronics.com)

